

Dredge Pump EDP450



The Eureka dredge pump (EDP) handles a high concentration. The efficiency is caused by the double curved impeller blades. For use in a dry environment a 60% level is needed to make the pump self-priming. The submersible version has an extra seal set on the drive shaft. The EDP pumps are built from separate wear-resistant parts to exchange wear parts easily and still work cost effective. The standard pumps have adjustable casting positions and can be mounted easily into an existing dredger. The EDP's have a long lifetime, low maintenance, optimum suction capacity and low energy consumption.

General information:

- Capacity max. 4500 m³/hr
- Work pressure max. 4.5 bar
- Pump shaft speed max. 480 rpm
- Power at shaft max. 680 kW
- Suction diameter 450 mm
- Pressure diameter 430 mm
- Spherical passage 280 mm
- Blades 3 pcs
- Impeller size 1170 mm
- Weight 5680 kg
- Material composition G-X300CrMo15-3
GS30 Mn5
Hardox 500

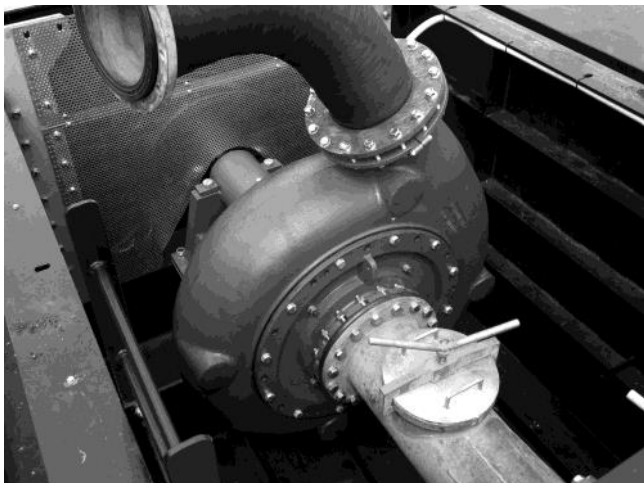
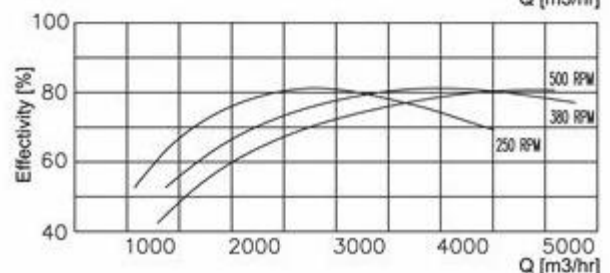
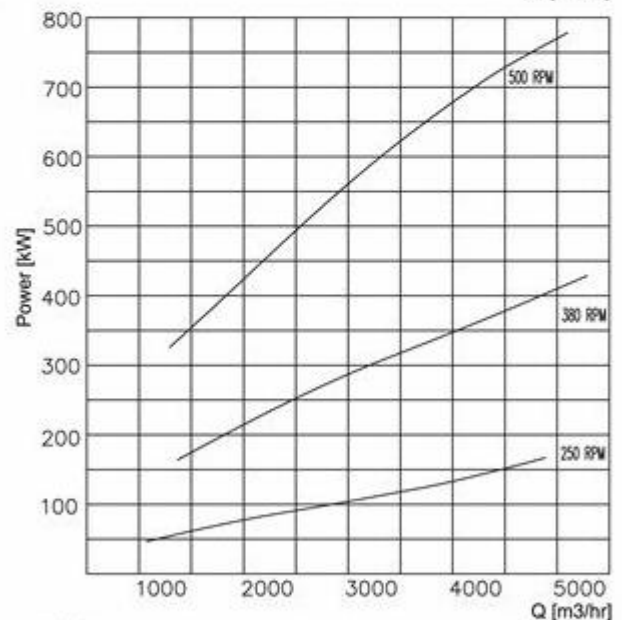
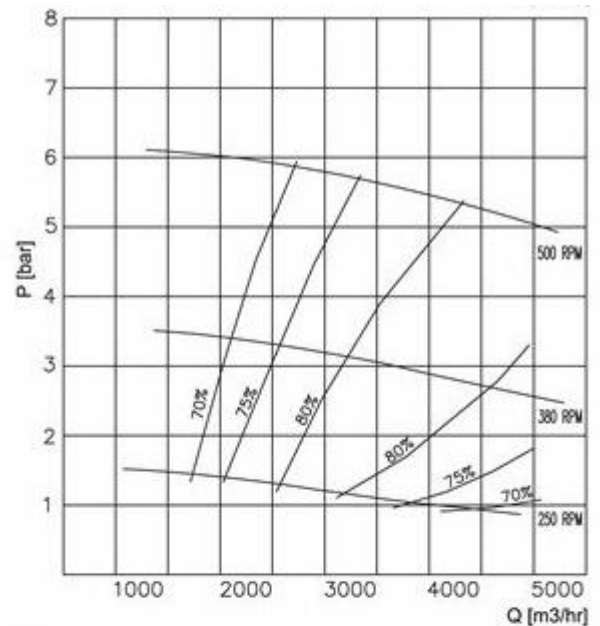

Dredge Pump EDP450

Main dimensions:

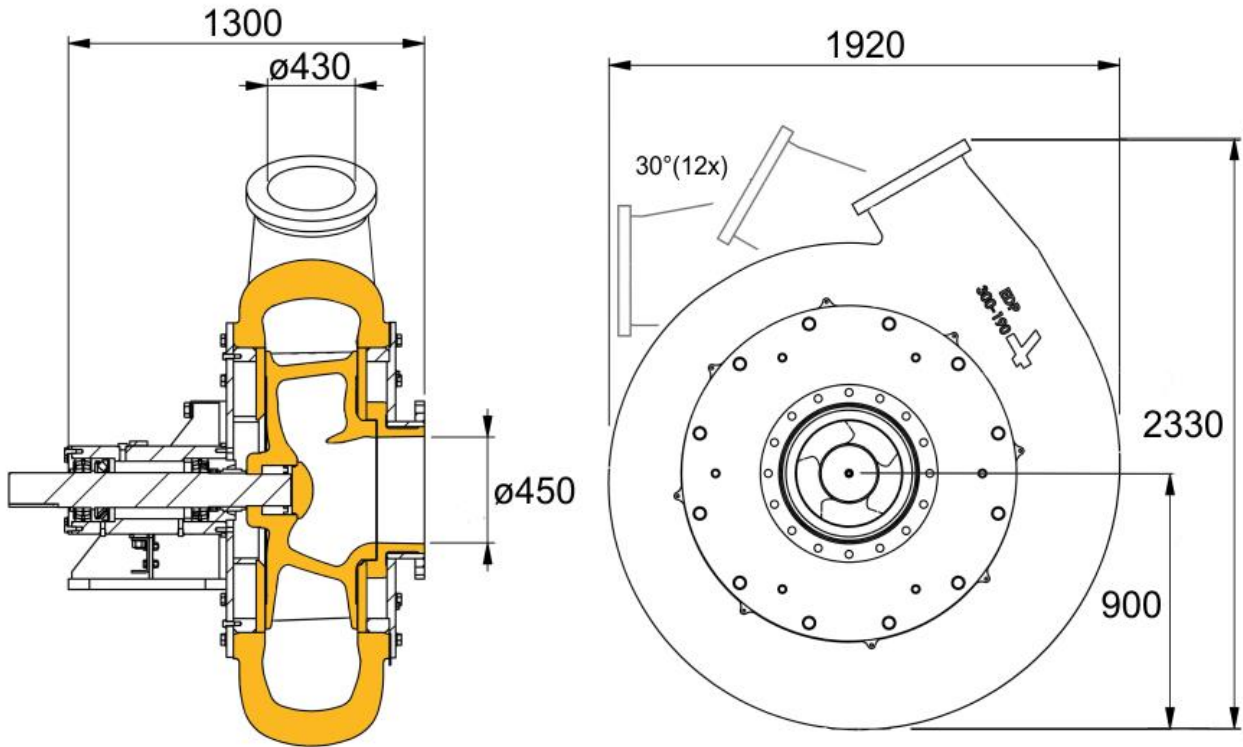

Delivery Pipe



Inspection hole



Cutter dredger Delta



Water jet head

EUREKA

www.eureka-bv.com

Maasstraat 3
NL-7071 VR ULFT
The Netherlands

Phone : 0 (031) 315 377 608
Fax : 0 (031) 315 377 609
Email : info@eureka-bv.com